



Schedule 80 CPVC Technical
Schedule 80 CPVC Fittings & Schedule 80 CPVC Unions

Double Wye - Reducing

(Continued)

Socket x Socket x Socket x Socket

Size 3" is 150 psi, all Fabricated Sizes- 100 psi
 Maximum Internal Pressure Rating @ 73°F (23°C)

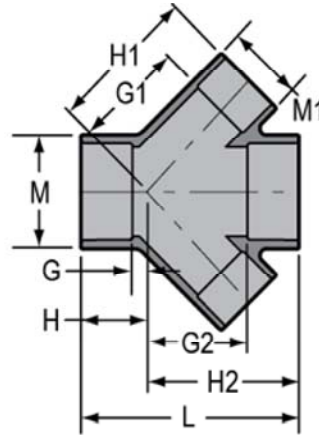

Part Number	Size	G	G1	G2	H	H1	H2	L	M	M1	Approx. Wt. (Lbs.)
876-585CF ^{2*}	8X6	4-15/16	13-15/16	13- 9/16	9- 3/16	17- 3/16	17-13/16	27	9- 5/8	7- 1/2	41.47
876-621CF ^{2*}	10X2	1/4	11- 7/8	10- 1/2	5	13- 5/8	15- 3/4	20- 3/4	11-15/16	2-13/16	26.33
876-622CF ^{2*}	10X2-1/2	1/8	12- 5/16	10- 7/8	5- 3/8	14- 5/16	16- 1/8	21- 1/2	11-15/16	3- 7/16	28.27
876-623CF ^{2*}	10X3	3/4	13	11- 1/2	6	15- 1/4	16- 3/4	22- 3/4	11-15/16	4- 1/8	24.66
876-624CF ^{2*}	10X4	1- 3/4	13- 1/4	12- 1/2	7	15- 1/2	17- 3/4	24- 3/4	11-15/16	5- 3/16	35.90
876-626CF ^{2*}	10X6	3- 3/4	15- 5/16	14- 1/2	9	18- 9/16	19- 3/4	28- 3/4	11-15/16	7- 1/2	46.54
876-628CF ^{2*}	10X8	5- 1/4	17- 1/4	16	10- 1/2	21- 1/2	21- 1/4	31- 3/4	11-15/16	9- 5/8	70.04
876-661CF ^{2*}	12X2	1- 5/16	13- 3/16	11- 7/16	4-15/16	14-15/16	17-11/16	22- 5/8	14- 1/8	2-13/16	39.61
876-662CF ^{2*}	12X2-1/2	15/16	13- 5/8	11-13/16	5- 5/16	15- 5/8	18- 1/16	23- 3/8	14- 1/8	3- 7/16	41.99
876-663CF ^{2*}	12X3	1/8	14-15/16	12- 7/8	6- 3/8	16- 9/16	19- 1/8	25- 1/2	14- 1/8	4- 1/8	46.17
876-664CF ^{2*}	12X4	5/8	14- 9/16	13- 3/8	6- 7/8	16-13/16	19- 5/8	26- 1/2	14- 1/8	5- 3/16	49.77
876-666CF ^{2*}	12X6	2- 5/8	16- 5/8	15- 3/8	8- 7/8	19- 7/8	21- 5/8	30- 1/2	14- 1/8	7- 1/2	63.29
876-668CF ^{2*}	12X8	4- 1/4	18- 9/16	17	10- 1/2	22-13/16	23- 1/4	33- 3/4	14- 1/8	9- 5/8	79.18
876-670CF ^{2*}	12X10	5- 3/4	20- 3/16	18- 1/2	12	25- 7/16	24- 3/4	36- 3/4	14- 1/8	11-15/16	102.16

² Fiberglass reinforced.
 * Fabricated

Union 2000 - Socket/FKM

Socket x Socket with FKM O-ring Seal

Dimensions Also Applicable to
 8097-XXXC EPDM O-Ring Seals

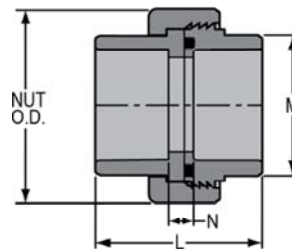

Pressure Rating
 1/4" - 4" 235 psi @ 73°F
 6" 150 PSI @ 73°F

Part Number	Size	L	M	N	NUT O.D.	Approx. Wt. (Lbs.)
857-002C	1/4	1-15/16	29/32	11/16	1-21/32	.09
857-003C	3/8	2- 5/32	1-1/16	5/8	1-25/32	.11
8057-005C	1/2	2- 3/32	1- 3/16	5/16	1-15/16	.12
8057-007C	3/4	2- 3/8	1-3/8	3/8	2-3/8	.20
8057-010C	1	2-11/16	1-23/32	13/32	2-21/32	.28
8057-012C	1-1/4	2-15/16	2- 3/32	1-3/32	3- 3/32	.41
8057-015C	1-1/2	3- 1/4	2-11/32	1/2	3-19/32	.54
8057-020C	2	3-9/16	2- 7/8	17/32	4-5/16	.90
8057-025C	2-1/2	4- 7/32	3- 1/2	11/16	6-3/16	2.25
8057-030C	3	4-5/16	4-5/32	17/32	6-3/16	2.27

Schedule 80 CPVC Technical
Schedule 80 CPVC Unions



Union 2000 - Socket/FKM

(Continued)

Socket x Socket with FKM O-ring Seal
Dimensions Also Applicable to
8097-XXXC EPDM O-Ring Seals

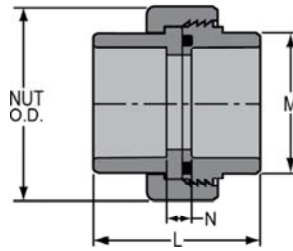

Pressure Rating
1/4" - 4" 235 psi @ 73°F
6" 150 PSI @ 73°F

Part Number	Size	L	M	N	NUT O.D.	Approx. Wt. (Lbs.)
8057-040C	4	5-3/16	5- 1/4	21/32	7- 3/4	4.02
8057-060C	6	6-29/32	7-21/32	27/32	11- 5/8	12.44

Union 2000 - Socket/Fipt/FKM

Socket x Fipt with FKM O-ring Seal
Dimensions Also Applicable to
8099-XXXC EPDM O-Ring Seals

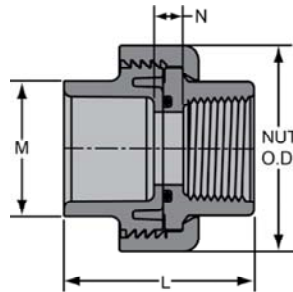

Pressure Rating
1/2" - 4" 235 psi @ 73°F
6" 150 PSI @ 73°F

Part Number	Size	L	M	N	NUT O.D.	Approx. Wt. (Lbs.)
8059-005C	1/2	1-7/8	1-3/16	5/16	1-15/16	.12
8059-007C	3/4	2- 1/16	1-3/8	3/8	2-3/8	.19
8059-010C	1	2-7/16	1-11/16	1/2	2-21/32	.27
8059-012C	1-1/4	2-5/8	2-1/16	1/2	3-3/16	.40
8059-015C	1-1/2	2-13/16	2-11/32	17/32	3-19/32	.53
8059-020C	2	3	2- 7/8	9/16	4-5/16	.88
8059-025C	2-1/2	3-15/32	3- 1/2	13/32	6- 3/16	2.28
8059-030C	3	3-13/16	4-5/32	5/8	6-3/16	2.26
8059-040C	4	4- 3/8	5- 1/4	11/16	7- 3/4	3.85
8059-060C	6	6-27/32	7-21/32	1-17/32	11- 5/8	11.98

Union 2000 - Socket/Spigot/FKM

Socket x Spigot with FKM O-ring Seal
Dimensions Also Applicable to
8096-XXXC EPDM O-Ring Seals

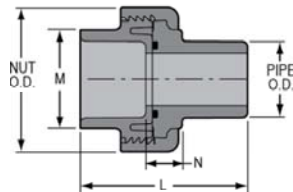

Pressure Rating
1/2" - 4" 235 psi @ 73°F
6" 150 PSI @ 73°F

Part Number	Size	L	M	N	NUT O.D.	Approx. Wt. (Lbs.)
8056-005C	1/2	2-11/32	1- 3/16	9/16	1-15/16	.13
8056-007C	3/4	2- 5/8	1- 3/8	19/32	2-3/8	.20
8056-010C	1	2-15/16	1-23/32	11/16	2-21/32	.29
8056-012C	1-1/4	3- 7/32	2- 3/32	11/16	3- 3/16	.43
8056-015C	1-1/2	3- 1/2	2-11/32	23/32	3-19/32	.55
8056-020C	2	3-25/32	2- 7/8	3/4	4- 5/16	.92



Schedule 80 CPVC Technical
Schedule 80 CPVC Unions

Union 2000 -

(Continued)

Socket/Spigot/FKM

Socket x Spigot with FKM O-ring Seal
 Dimensions Also Applicable to
 8096-XXXC EPDM O-Ring Seals

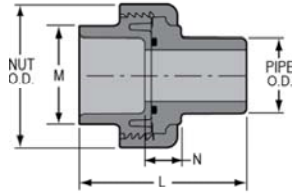

Pressure Rating
 1/2" - 4" 235 psi @ 73°F
 6" 150 PSI @ 73°F

Part Number	Size	L	M	N	NUT O.D.	Approx. Wt. (Lbs.)
8056-025C	2-1/2	4-21/32	3-1/2	1-1/8	6-3/16	2.32
8056-030C	3	4-3/4	4- 5/32	31/32	6-3/16	2.35
8056-040C	4	5- 5/8	5- 1/4	1- 1/8	7-23/32	4.09
8056-060C	6	7-5/8	7- 9/16	1- 1/2	11-11/16	12.86

Union 2000 - Special Reinforced Fipt/Spigot/FKM

SR Fipt x Spigot with FKM O-ring Seal
 Dimensions Also Applicable to
 8095-XXXCSR EPDM O-Ring Seals

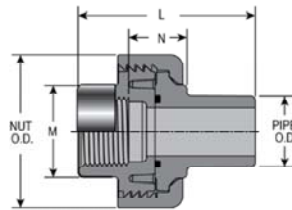

Pressure Rating
 1/2" - 4" 235 psi @ 73°F
 6" 150 PSI @ 73°F

Part Number	Size	L	M	N	NUT O.D.	Approx. Wt. (Lbs.)
8055-005CSR	1/2	2-13/32	1-7/32	25/32	1-15/16	.14
8055-007CSR	3/4	2-21/32	1-3/8	29/32	2-3/8	.22
8055-010CSR	1	3-1/16	1-23/32	1-1/16	2-21/32	.34
8055-012CSR	1-1/4	3-5/16	2-3/32	1-1/16	3-3/16	.47
8055-015CSR	1-1/2	3-15/32	2-7/16	1-3/32	3-19/32	.61
8055-020CSR	2	3-31/32	3-1/32	1-15/32	4-5/16	1.02
8055-025CSR	2-1/2	4-9/32	3-19/32	1-27/32	6-3/16	2.51
8055-030CSR	3	5-1/8	4-9/32	1-27/32	6-3/16	2.59
8055-040CSR	4	6	5-1/4	2-7/32	7-3/4	4.38
8055-060CSR	6	7-19/32	7-19/32	2-7/8	11-5/8	13.16

Union 2000 - Fipt/FKM

Fipt x Fipt with FKM O-ring Seal
 Dimensions Also Applicable to
 8098-XXXC EPDM O-Ring Seals

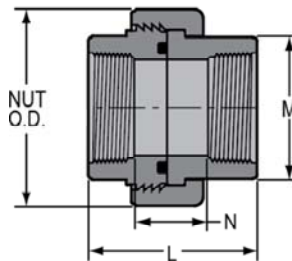

Pressure Rating
 1/4" - 4" 235 psi @ 73°F
 6" 150 PSI @ 73°F

Part Number	Size	L	M	N	NUT O.D.	Approx. Wt. (Lbs.)
858-002C	1/4	1-15/16	15/16	3/4	1-21/32	.10
858-003C	3/8	2-5/32	1- 1/32	31/32	1-25/32	.13
8058-005C	1/2	1-29/32	1- 3/16	17/32	1- 7/8	.13
8058-007C	3/4	2-3/32	1- 3/8	3/4	2-3/8	.20

Schedule 80 CPVC Technical
Schedule 80 CPVC Unions



Union 2000 - Fipt/FKM

Fipt x Fipt with FKM O-ring Seal
Dimensions Also Applicable to
8098-XXXC EPDM O-Ring Seals

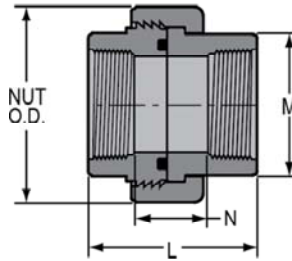

(Continued)

Pressure Rating
1/4" - 4" 235 psi @ 73°F
6" 150 PSI @ 73°F

Part Number	Size	L	M	N	NUT O.D.	Approx. Wt. (Lbs.)
8058-010C	1	2-9/16	1-11/16	29/32	2- 9/16	.29
8058-012C	1-1/4	2-23/32	2-1/16	7/8	3-3/16	.42
8058-015C	1-1/2	2-3/16	2- 3/8	1	3-19/32	.56
8058-020C	2	3-3/16	3	1-1/4	4-5/16	.94
8058-025C	2-1/2	4-1/16	3- 9/16	1-15/32	6-3/16	2.41
8058-030C	3	4-3/16	4- 9/32	1-1/2	6-3/16	2.48
8058-040C	4	4-11/16	5- 1/4	1-13/16	7- 3/4	4.05
8058-060C	6	6-7/32	7-21/32	2-13/16	11-5/8	12.14

Union 2000 - Socket/Special Reinforced Fipt/FKM

Socket x SR Fipt with FKM O-ring Seal
Dimensions Also Applicable to
8099-XXXCSR EPDM O-Ring Seals

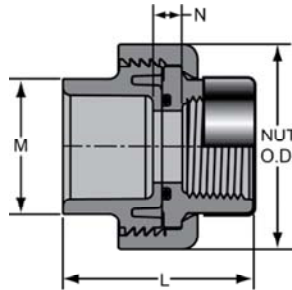

Pressure Rating
1/2" - 4" 235 psi @ 73°F
6" 150 PSI @ 73°F

Part Number	Size	L	M	N	NUT O.D.	Approx. Wt. (Lbs.)
8059-005CSR	1/2	1-29/32	1- 3/16	9/32	1-15/16	.13
8059-007CSR	3/4	2-3/32	1-3/8	11/32	2-3/8	.20
8059-010CSR	1	2-15/32	1-23/32	13/32	2-21/32	.29
8059-012CSR	1-1/4	2-21/32	2- 3/32	7/16	3-7/32	.42
8059-015CSR	1-1/2	2-27/32	2-11/32	1/2	3-19/32	.56
8059-020CSR	2	3-1/32	2- 7/8	1/2	4-5/16	.92
8059-025CSR	2-1/2	3-27/32	3-1/2	3/4	6- 3/16	2.32
8059-030CSR	3	3-13/16	4-5/32	1/2	6-3/16	2.34
8059-040CSR	4	4-11/32	5- 1/4	5/8	7- 3/4	3.95
8059-060CSR	6	6-1/4	7-21/32	1-17/32	11-9/16	12.13



Schedule 80 CPVC Technical
Schedule 80 CPVC Unions

Union 2000 - Special Reinforced Fipt/FKM

SR Fipt x SR Fipt w/FKM O-ring Seal - Stainless Steel Collar
 Dimensions Also Applicable to
 8098-XXXCSR EPDM O-Ring Seals

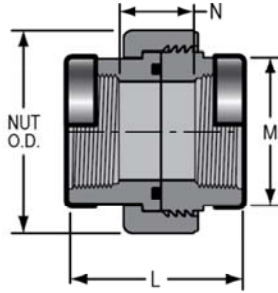

Pressure Rating
 1/2" - 4" 235 psi @ 73°F
 6" 150 PSI @ 73°F

Part Number	Size	L	M	N	NUT O.D.	Approx. Wt. (Lbs.)
8058-005CSR	1/2	2	1-7/32	9/16	1-15/16	.15
8058-007CSR	3/4	2-1/8	1- 3/8	23/32	2-3/8	.22
8058-010CSR	1	2-19/32	1-23/32	29/32	2-21/32	.34
8058-012CSR	1-1/4	2-3/4	2-3/32	29/32	3-3/16	.46
8058-015CSR	1-1/2	2-27/32	2-7/16	1-1/32	3-19/32	.62
8058-020CSR	2	3-3/16	3- 1/32	1-9/32	4-5/32	1.02
8058-025CSR	2-1/2	4-3/32	3-19/32	1-9/16	6-3/16	2.51
8058-030CSR	3	4-7/32	4- 9/32	1-1/2	6-3/16	2.58
8058-040CSR	4	4-3/4	5- 1/4	1-13/16	7-3/4	4.24
8058-060CSR	6	6-1/4	7-19/32	2-31/32	11- 5/8	12.43

Union (Old Style) - Socket/FKM

Socket x Socket with FKM O-ring Seal
 Dimensions Also Applicable to
 897-XXXC EPDM O-Ring Seals

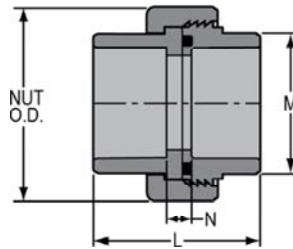

Pressure Rating
 235 psi @ 73°F

Part Number	Size	L	M	N	NUT O.D.	Approx. Wt. (Lbs.)
857-005C	1/2	2-1/16	1- 9/32	5/16	1-31/32	.15
857-007C	3/4	2-13/32	1-17/32	11/32	2- 1/2	.28
857-010C	1	2- 9/16	1-7/8	5/16	2- 7/8	.39
857-012C	1-1/4	2- 7/8	2- 7/32	11/32	3- 5/16	.52
857-015C	1-1/2	3-5/32	2- 9/16	15/32	3-17/32	.64
857-020C	2	3- 5/8	3-1/16	9/16	4- 3/16	1.01
857-025C	2-1/2	4- 3/8	3- 5/8	7/8	4- 7/8	1.58
857-030C	3	5	4- 3/8	1-7/32	5- 3/4	2.51
857-040C	4	5-27/32	5-13/32	1-11/32	7- 1/8	3.97

Schedule 80 CPVC Technical
Schedule 80 CPVC Unions



Union (Old Style) - Socket/Fipt/FKM

Socket x Fipt with FKM O-ring Seal
 Dimensions Also Applicable to
 899-XXXC EPDM O-Ring Seals

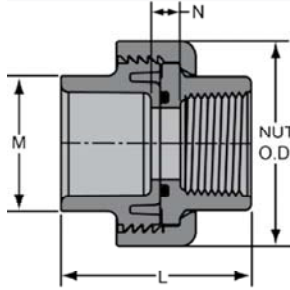

Pressure Rating
 235 psi @ 73°F

Part Number	Size	L	M	N	NUT O.D.	Approx. Wt. (Lbs.)
859-005C	1/2	2-1/16	1-5/16	7/16	1-31/32	.16
859-007C	3/4	2-13/32	1-17/32	19/32	2- 1/2	.29
859-010C	1	2- 9/16	1-7/8	7/16	2- 7/8	.40
859-012C	1-1/4	2- 7/8	2-1/4	19/32	3- 5/16	.54
859-015C	1-1/2	3-3/16	2-9/16	27/32	3- 9/16	.66
859-020C	2	3- 5/8	3-1/16	1-1/8	4- 3/16	1.06
859-025C	2-1/2	4-13/32	3- 5/8	1-13/32	4- 7/8	1.65
859-030C	3	5-1/32	4- 3/8	1-19/32	5- 3/4	2.60
859-040C	4	5- 7/8	5-13/32	1- 7/8	7-1/8	4.12

Union - Socket/Brass Fipt/FKM

Socket x Fipt with Brass Thread Insert & FKM O-ring Seal
 Dimensions Also Applicable to
 899-XXXCBR EPDM O-Ring Seals

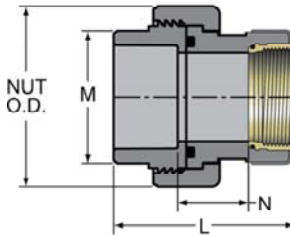

Pressure Rating
 235 psi @ 73°F

Part Number	Size	L	M	N	NUT O.D.	Approx. Wt. (Lbs.)
859-005CBR	1/2	2-1/4	1-9/32	25/32	1-15/16	.22
859-007CBR	3/4	2-11/16	1-17/32	1	2- 1/2	.36
859-010CBR	1	2-13/16	1- 7/8	1- 1/32	2- 7/8	.53
859-012CBR	1-1/4	3-5/16	2-1/4	1-5/16	3- 5/16	.76
859-015CBR	1-1/2	3-9/16	2- 9/16	1-13/32	3-17/32	.92
859-020CBR	2	3-19/32	2- 7/8	1-5/16	4- 5/16	1.63

Not intended to convey or dispense water for human consumption through drinking or cooking

Union (Old Style) - Fipt/FKM

Fipt x Fipt with FKM O-ring Seal
 Dimensions Also Applicable to
 898-XXXC EPDM O-Ring Seals

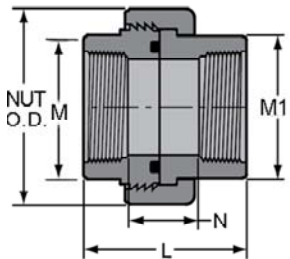

Pressure Rating
 235 psi @ 73°F

Part Number	Size	L	M	M1	N	NUT O.D.	Approx. Wt. (Lbs.)
858-005C	1/2	2-1/16	1- 9/32	1-9/32	19/32	1-31/32	.16
858-007C	3/4	2- 3/8	1-17/32	1-17/32	13/16	2- 1/2	.30



Schedule 80 CPVC Technical
Schedule 80 CPVC Unions

Union (Old Style) - Fipt/FKM

(Continued)

Fipt x Fipt with FKM O-ring Seal

Dimensions Also Applicable to
 898-XXXC EPDM O-Ring Seals

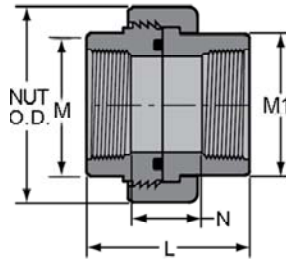

Pressure Rating
 235 psi @ 73°F

Part Number	Size	L	M	M1	N	NUT O.D.	Approx. Wt. (Lbs.)
858-010C	1	2- 9/16	1-27/32	1-7/8	19/32	2- 7/8	.41
858-012C	1-1/4	2- 7/8	2- 7/32	2-27/32	7/8	3- 5/16	.61
858-015C	1-1/2	3-3/16	2-1/2	2-9/16	1-7/32	3-17/32	.69
858-020C	2	3-19/32	3	3-1/16	1-19/32	4- 3/16	1.11
858-025C	2-1/2	4- 3/8	3- 5/8	3-5/8	1-25/32	4- 7/8	1.74
858-030C	3	5	4- 3/8	4-3/8	1-13/16	5- 3/4	2.66
858-040C	4	5- 7/8	5-3/8	5-13/32	2-5/8	7-1/8	4.29

**Union (Old Style) -
 Socket/Special Reinforced
 Fipt/FKM**

Socket x SR Fipt w/FKM O-ring Seal - Stainless Steel Collar

Dimensions Also Applicable to
 899-XXXCSR EPDM O-Ring Seals

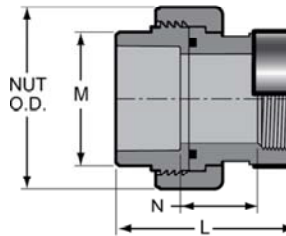

Pressure Rating
 235 psi @ 73°F

Part Number	Size	L	M	N	NUT O.D.	Approx. Wt. (Lbs.)
859-002CSR	1/4	2-1/8	15/16	7/8	1-21/32	.07
859-003CSR	3/8	2-5/16	1-1/16	1-5/16	1-25/32	.07
859-005CSR	1/2	2- 9/32	1- 9/32	21/32	1-31/32	.16
859-007CSR	3/4	2-19/32	1-17/32	25/32	2- 1/2	.29
859-010CSR	1	2-15/16	1-29/32	29/32	2- 7/8	.43
859-012CSR	1-1/4	3-7/32	2- 7/32	31/32	3- 5/16	.57
859-015CSR	1-1/2	3-7/16	2- 9/16	1- 1/32	3- 9/16	.71
859-020CSR	2	4- 3/32	3-1/16	1-19/32	4- 3/16	1.17
859-030CSR	3	5- 1/4	4-13/32	2	5- 3/4	2.74
859-040CSR	4	5-5/16	5-13/32	2-7/32	7-1/8	4.19