

Fabricated Fittings Technical  
**PVC Schedule 40 & 80 DWV Fabricated Fittings**

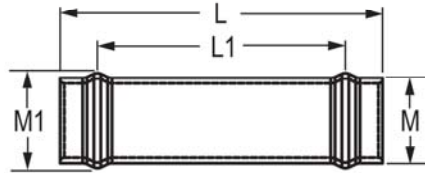

### Repair Coupling SCH 80

Gasket x Gasket



Part Number	Size	L	L1	M	M1	Approx. Wt. (Lbs.)
<a href="#">3928-040</a>	4	19-1/2	15	5-3/16	5-3/4	5.68
<a href="#">3928-060</a>	6	23	18-1/4	7-1/2	8-1/8	12.61
<a href="#">3928-080</a>	8	26-1/8	19	9-5/8	10-3/8	21.38
<a href="#">3928-100</a>	10	28	21-1/4	11-15/16	13-1/8	34.00
<a href="#">3928-120</a>	12	29	21-3/8	14-1/8	15-3/8	49.16
<a href="#">3928-140</a>	14	30	21	15-1/2	17-1/4	62.11
<a href="#">3928-160</a>	16	31	22-1/4	17-11/16	18-7/8	75.99
<a href="#">3928-180</a>	18	32	22-5/8	19-7/8	21-7/8	73.10
<a href="#">3928-200</a>	20	32	23-1/2	22-1/16	24-1/16	113.21
<a href="#">3928-240</a>	24	32	23-1/2	26-7/16	28-13/16	142.50

### Reducer Coupling- SCH 40

Socket X Socket

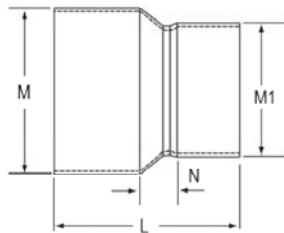

Part Number	Size	L	M	M1	N	Approx. Wt. (Lbs.)
<a href="#">3729-528</a>	6X2	9-1/4	7-1/8	5-5/16	4-5/8	2.77
<a href="#">3729-530</a>	6X3	11-15/16	7-1/8	3-15/16	6-7/16	2.64
<a href="#">3729-532</a>	6X4	8-7/8	7- 3/32	5- 1/32	3- 1/4	2.04
<a href="#">3729-578</a>	8X2	14-7/8	9-3/16	5-5/16	9-1/4	5.75
<a href="#">3729-580</a>	8X3	17-9/16	9-3/16	3-15/16	11-1/16	5.17
<a href="#">3729-582</a>	8X4	14- 1/2	9-3/16	5	8	4.80
<a href="#">3729-585</a>	8X6	11-1/2	9-3/16	7-3/16	3-1/2	3.73
<a href="#">3729-621</a>	10X2	17-3/4	11-3/8	5-5/16	11-1/8	8.57
<a href="#">3729-623</a>	10X3	20-7/16	11-3/8	3-15/16	12-15/16	7.48
<a href="#">3729-624</a>	10X4	17-3/8	11-3/8	5	9-7/8	7.18
<a href="#">3729-626</a>	10X6	13-7/8	11-3/8	7-1/4	5-3/8	6.61
<a href="#">3729-628</a>	10X8	13-1/4	11-9/16	9-7/16	3-3/4	8.95
<a href="#">3729-661</a>	12X2	24-3/8	13-9/16	5-5/16	16-3/4	16.96



**Fabricated Fittings Technical**  
**PVC Schedule 40 & 80 DWV Fabricated Fittings**

**Reducer Coupling- SCH 40**

(Continued)

Socket X Socket

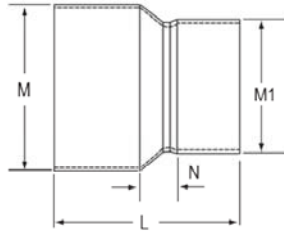

Part Number	Size	L	M	M1	N	Approx. Wt. (Lbs.)
3729-663	12X3	27-1/16	13-1/2	3-15/16	18-9/16	15.85
3729-664	12X4	24	13-9/16	5	15-1/2	15.20
3729-666	12X6	20-1/2	13-9/16	7-1/4	11	14.72
3729-668	12X8	15-3/4	13-9/16	9-7/16	5-1/4	12.30
3729-670	12X10	15-1/8	13-9/16	11-9/16	3-5/8	14.44
3729-691	14X2	26-1/4	14-13/16	5-5/16	17-7/8	25.97
3729-693	14X3	28-15/16	14-13/16	3-15/16	19-11/16	21.12
3729-694	14X4	25-7/8	14-13/16	5	16-5/8	17.51
3729-696	14X6	22-3/8	14-13/16	7-1/4	12-1/8	17.18
3729-698	14X8	21-3/4	14-3/4	9-7/16	10-1/2	20.81
3729-700	14X10	17	14-13/16	11-9/16	4-3/4	14.51
3729-702	14X12	16-1/2	15	13-3/4	3-1/4	19.05
3729-754	16X4	32-1/2	17	5	22-1/4	29.72
3729-756	16X6	29	17	7-3/16	17-3/4	30.08
3729-758	16X8	24-3/4	17	9-7/16	12-1/2	28.87
3729-760	16X10	24	17	11-9/16	10-3/4	30.50
3729-762	16X12	18-7/8	17	13-3/4	4-5/8	22.64
3729-764	16X14	18-1/2	16-7/8	14-7/8	3-1/2	22.84
3729-786	18X6	38	19	7-3/16	25-3/4	50.29
3729-788	18X8	33-3/4	19	9-7/16	20-1/2	46.36
3729-790	18X10	33-3/4	19	9-7/16	20-1/2	46.43
3729-792	18X12	33	19	11-9/16	18-3/4	44.77
3729-794	18X14	27-7/8	19	13-3/4	12-5/8	43.64
3729-796	18X16	21-5/8	19	17	4-5/8	30.97
3729-816	20X6	47	21-1/8	7-3/16	33-3/4	74.44
3729-818	20X8	42-3/4	21-1/8	9-7/16	28-1/2	72.15
3729-820	20X10	42	21-1/8	11-9/16	26-3/4	82.75
3729-822	20X12	36-7/8	21-1/8	13-3/4	20-5/8	76.33
3729-824	20X14	36-1/2	21-1/8	14-7/8	19-1/2	74.41
3729-826	20X16	30-5/8	21-1/8	17	12-5/8	58.52
3729-828	20X18	23-1/4	21-1/8	19-1/8	4-1/4	46.31
3729-906	24X6	59-1/4	25-3/16	7-3/16	44	132.86
3729-908	24X8	55	25-3/16	9-7/16	38-3/4	126.86
3729-910	24X10	54-1/4	25-3/16	11-9/16	37	128.19
3729-912	24X12	49-1/8	25-3/16	13-3/4	30-7/8	108.48
3729-914	24X14	48-3/4	25-3/16	14-7/8	29-3/4	106.10
3729-916	24X16	42-7/8	25-3/16	17	22-7/8	108.17
3729-918	24X18	35-1/2	25-3/16	19-1/8	14-1/2	90.89
3729-920	24X20	28-3/4	25-3/16	21-3/16	6-3/4	66.93

**Fabricated Fittings Technical**  
**PVC Schedule 40 & 80 DWV Fabricated Fittings**



**Reducer Coupling- SCH 40**

(Continued)

Socket X Socket

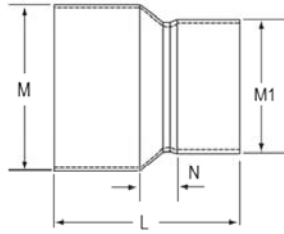

-2 Step Reducer -3 Step Reducer -4 4 Step Reducer

**Reducer Coupling- SCH 80**

Socket X Socket

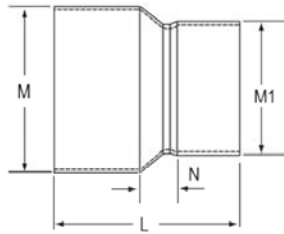

Part Number	Size	L	M	M1	N	Approx. Wt. (Lbs.)
3929-528	6X2	14-5/8	7-5/16	2-13/16	9-5/8	3.63
3929-530	6X3	12-1/4	7-5/16	4-1/8	6-3/4	3.52
3929-532	6X4	8-7/8	7-5/16	5-3/16	3-3/8	2.68
3929-578	8X2	20-3/8	9-1/2	2-13/16	14-3/8	8.25
3929-580	8X3	18	9- 1/2	4- 1/8	11-1/2	8.37
3929-582	8X4	14-5/8	9- 1/2	5-3/16	8-1/8	7.15
3929-585	8X6	11	9-1/2	7-1/2	3-1/2	7.01
3929-624	10X4	21-1/8	11-3/4	5-3/16	13-5/8	14.75
3929-626	10X6	17-1/2	11- 3/4	7- 1/2	9	16.01
3929-628	10X8	13-1/4	11-3/4	9-5/8	3-3/4	11.36
3929-664	12X4	28-3/8	13-15/16	5-3/16	19-7/8	30.99
3929-666	12X6	24-3/4	13-15/16	7- 1/2	15-1/4	30.03
3929-668	12X8	20-1/2	13-15/16	9-5/8	10	26.08
3929-670	12X10	16-3/8	13-15/16	11-15/16	4-7/8	20.57
3929-694	14X4	30-1/8	15-3/16	5-3/16	20-7/8	29.93
3929-696	14X6	26-1/2	15-3/16	7-1/2	16-1/4	33.67
3929-698	14X8	22-1/4	15-3/16	9- 5/8	11	31.22
3929-700	14X10	18-1/8	15-3/16	11-15/16	5-7/8	24.68
3929-702	14X12	17-3/4	15-3/8	14-1/8	4-1/2	27.40
3929-754	16X4	38	17-3/8	5-3/16	27-3/4	50.44
3929-756	16X6	34-3/8	17-3/8	7-1/2	23-1/8	57.36
3929-758	16X8	30-1/8	17-3/8	9-5/8	17-7/8	53.41
3929-760	16X10	26	17-3/8	11-15/16	12-3/4	47.90
3929-762	16X12	20-1/4	17-3/8	14-1/8	6	37.66
3929-764	16X14	20-1/4	17-1/2	15-1/2	5-1/4	42.89
3929-786	18X6	43-3/4	19-11/16	7-1/2	31-1/2	93.96
3929-788	18X8	39-1/2	19-11/16	9-5/8	26-1/4	89.60



**Fabricated Fittings Technical**  
**PVC Schedule 40 & 80 DWV Fabricated Fittings**

**Reducer Coupling- SCH 80**

(Continued)

Socket X Socket

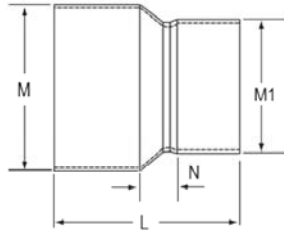

Part Number	Size	L	M	M1	N	Approx. Wt. (Lbs.)
3929-906	24X6	67-7/8	26-1/16	7-1/2	52-5/8	228.78
3929-908	24X8	63-5/8	26-1/16	9-5/8	47-3/8	228.25
3929-910	24X10	59-1/2	26-1/16	11-15/16	42-1/4	219.32
3929-912	24X12	53-3/4	26-1/16	14-1/8	35-1/2	192.81
3929-914	24X14	53-3/4	26-1/16	15-1/2	34-3/4	210.21
3929-916	24X16	47-1/8	26-1/16	17-11/16	27-1/8	187.81
3929-918	24X18	39	26-1/16	19-7/8	18	162.85
3929-920	24X20	30-5/8	26-1/16	22-1/16	8-5/8	123.13

**Eccentric Reducer Coupling- SCH 40**

Socket X Socket

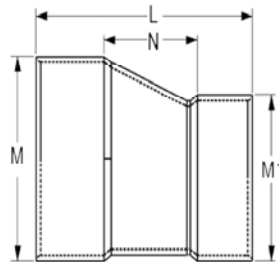

Part Number	Size	L	M	M1	N	Approx. Wt. (Lbs.)
3729-338E	3X2	7-15/16	3-13/16	2-11/16	3-15/16	.61
3729-420E <sup>2</sup>	4X2	12-1/4	4-15/16	2-11/16	8-1/2	2.14
3729-422E	4X3	8-5/8	4-15/16	3-15/16	4-1/8	1.22
3729-528E <sup>2</sup>	6X2	15-9/16	7-1/8	2-3/4	10-15/16	3.51
3729-530E <sup>2</sup>	6X3	16-5/16	7-1/8	3-15/16	10-13/16	3.16
3729-532E <sup>1</sup>	6X4	10-13/16	7-1/8	5	5-5/16	2.27
3729-580E <sup>3</sup>	8X3	25	9-3/16	3-15/16	18-1/2	7.18
3729-582E <sup>2</sup>	8X4	19-11/16	9-3/16	5	13-7/16	8.21
3729-585E	8X6	14-3/8	9-3/16	7-3/16	6-7/8	4.85
3729-624E <sup>2</sup>	10X4	22-7/16	11-3/8	5	15-3/16	10.13
3729-626E	10X6	17-1/8	11-3/8	7-1/4	8-5/8	7.48
3729-628E	10X8	16-11/16	11-3/8	9-1/4	7-3/16	8.48
3729-664E <sup>3</sup>	12X4	32-7/16	13-1/2	5	24-3/16	20.15
3729-666E <sup>2</sup>	12X6	27-1/8	13-1/2	7-1/4	17-5/8	16.79
3729-668E <sup>2</sup>	12X8	26-11/16	13-1/2	9-1/4	16-3/16	18.12
3729-670E	12X10	18-3/8	13-1/2	11-1/2	6-7/8	13.53
3729-696E <sup>2</sup>	14X6	31-3/8	15	7-1/4	21-1/8	26.14
3729-698E <sup>2</sup>	14X8	30-15/16	15	9-1/4	19-1/16	26.76
3729-700E <sup>1</sup>	14X10	22-3/4	15	11-3/4	10-1/2	23.23

**Fabricated Fittings Technical**  
**PVC Schedule 40 & 80 DWV Fabricated Fittings**



**Eccentric Reducer Coupling-  
SCH 40**

Socket X Socket

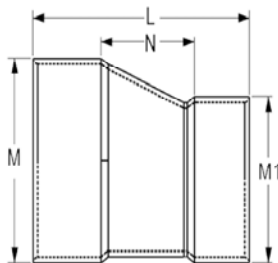

(Continued)

Part Number	Size	L	M	M1	N	Approx. Wt. (Lbs.)
3729-702E	14X12	19	15	13-3/4	5-3/4	21.29
3729-756E <sup>4</sup>	16X6	43-5/8	17	7-1/4	32-3/8	42.00
3729-758E <sup>3</sup>	16X8	43-3/16	17	9-1/4	30-15/16	42.02
3729-760E <sup>3</sup>	16X10	34-7/8	17	11-1/2	21-5/8	38.22
3729-762E	16X12	26-1/2	17	13-3/4	12-1/4	30.83
3729-764E	16X14	21-3/4	16-7/8	14-7/8	6-3/4	24.61
3729-786E <sup>5</sup>	18X6	56	19	7-1/4	43-3/4	71.11
3729-788E <sup>4</sup>	18X8	55-9/16	19	9-1/4	42-5/16	70.92
3729-790E <sup>3</sup>	18X10	47-1/4	19	11-1/2	33	65.31
3729-792E <sup>2</sup>	18X12	38-7/8	19	13-3/4	23-5/8	55.50
3729-794E <sup>2</sup>	18X14	34-1/8	19	14-7/8	18-1/8	49.03
3729-796E	18X16	25	19	17	8	38.72

**Eccentric Reducer Coupling-  
SCH 80**

Socket X Socket

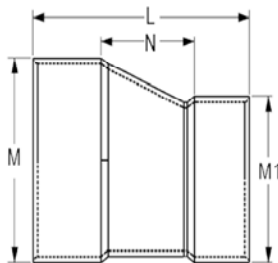

Part Number	Size	L	M	M1	N	Approx. Wt. (Lbs.)
3929-338E	3X2	8-1/8	3-15/16	2-13/16	4-1/8	1.00
3929-420E <sup>2</sup>	4X2	12-3/8	5- 1/8	2-13/16	8-5/8	2.62
3929-422E	4X3	8-3/4	5-1/8	4-1/8	4-1/4	1.69
3929-528E <sup>3</sup>	6X2	20	7-5/16	2-7/8	15-1/4	4.84
3929-530E <sup>2</sup>	6X3	16-3/8	7-5/16	4-1/8	10-7/8	4.57
3929-532E	6X4	11-1/8	7-5/16	5-3/16	5-5/8	3.39
3929-580E <sup>3</sup>	8X3	26-1/8	9-1/2	4-1/8	19-5/8	11.01
3929-582E <sup>2</sup>	8X4	20-7/8	9-1/2	5-3/16	14-3/8	10.24
3929-585E	8X6	15-1/4	9-1/2	7-1/2	7-3/4	8.40
3929-624E <sup>3</sup>	10X4	32	11-3/4	5	24-1/2	21.03
3929-626E <sup>2</sup>	10X6	26- 3/8	11- 3/4	7- 1/2	17- 7/8	18.61
3929-628E	10X8	18-1/16	11- 3/4	9- 5/8	8-9/16	13.81
3929-664E <sup>4</sup>	12X4	43-1/2	13-15/16	5-3/16	35	37.53
3929-666E <sup>3</sup>	12X6	37-7/8	13-15/16	7- 1/2	28-3/8	36.64
3929-668E <sup>2</sup>	12X8	29-9/16	13-15/16	9-5/8	19-1/16	32.09



**Fabricated Fittings Technical**  
**PVC Schedule 40 & 80 DWV Fabricated Fittings**

**Eccentric Reducer Coupling-  
SCH 80**

Socket X Socket

(Continued)

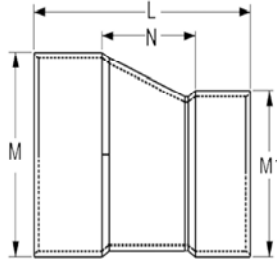

Part Number	Size	L	M	M1	N	Approx. Wt. (Lbs.)
3929-670E	12X10	20-5/8	13-15/16	11-15/16	9-1/8	23.62
3929-696E <sup>3</sup>	14X6	41-3/8	15-3/16	7-1/2	31-1/8	41.01
3929-698E <sup>2</sup>	14X8	33-1/16	15-3/16	9-5/8	21-13/16	35.00
3929-700E <sup>1</sup>	14X10	24-1/8	15-3/16	11-15/16	11-7/8	29.88
3929-702E	14X12	20-1/8	15-3/8	14-1/8	6-7/8	30.11
3929-756E <sup>4</sup>	16X6	54-1/4	17-1/2	7-1/2	43	73.56
3929-758E <sup>3</sup>	16X8	45-15/16	17-1/2	9-5/8	33-11/16	69.73
3929-760E <sup>2</sup>	16X10	37	17-1/2	11-15/16	23-3/4	59.25
3929-762E <sup>2</sup>	16X12	33	17-1/2	14-1/8	18-3/4	64.09
3929-764E	16X14	24-5/8	17-1/2	15-1/2	9-5/8	46.25
3929-786E <sup>5</sup>	18X6	69-1/4	19-11/16	7-1/2	57	121.36
3929-788E <sup>4</sup>	18X8	60-15/16	19-11/16	9-5/8	47-11/16	121.91
3929-790E <sup>3</sup>	18X10	52	19-11/16	11-15/16	37-3/4	109.42
3929-792E <sup>3</sup>	18X12	48	19-11/16	14-1/8	32-3/4	109.80
3929-794E <sup>2</sup>	18X14	39-5/8	19-11/16	15-1/2	23-5/8	97.05
3929-796E	18X16	28-5/8	19-11/16	17-11/16	11-5/8	66.92

**Cross SCH 40**

Socket x Socket x Socket x Socket

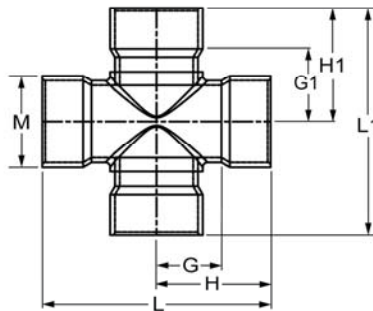

Part Number	Size	G	G1	H	H1	L	L1	M	Approx. Wt. (Lbs.)
3720-040	4	5-15/16	5-15/16	8-3/16	8-3/16	16-3/8	16-3/8	5	5.06
3720-060	6	6 3/16	6 3/16	9 7/16	9 7/16	18 7/8	18 7/8	7 3/16	9.74
3720-080	8	7-5/16	7-5/16	11-9/16	11-9/16	23-1/8	23-1/8	9-1/4	19.84
3720-100	10	9	8-3/8	14-1/4	13-5/8	28-1/2	27-1/4	11-1/2	30.13
3720-120	12	11-1/4	10-3/16	17-1/2	16-7/16	35	32-7/8	13-9/16	48.90
3720-140	14	11	11	18	18	36	36	14-7/8	64.38
3720-160	16	12-7/8	12-7/8	20-7/8	20-7/8	41-3/4	41-3/4	17	93.23